



**SANREMO**

OPERA<sup>2.0</sup>

**THE REVOLUTION**

---

Opera 2.0



**SANREMO**  
COFFEE MACHINES

**The Revolution**

*Be in control, express yourself*



**SANREMO**  
COFFEE MACHINES

Each coffee has its own feature,  
this is the perfect way to bring it up

**TAME IT WITH ONE FINGER**  
Easy-touch setting with 6 different profiles for individual groups

**SMART LEVER**  
Coffee doses fast manual selection

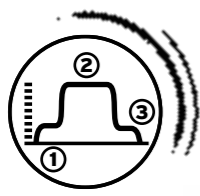

**CDS SYSTEM**  
Maximum precision and full control on the three phases of coffee extraction

**EVERYTHING UNDER CONTROL**  
System digital display to provide visibility of all working parameters



**POWER DRY STEAM**  
Silky milk at high capacity

**HEART OF STEEL**  
For maximum thermal stability:  
• Groups in AISI 316 weight 22 lb / 10 kg each  
• Portafilters AISI 316  
• Boilers AISI 316

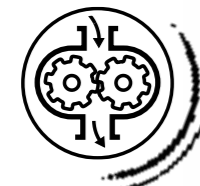

**GEAR PUMP PERFORMANCE**  
High and constant pressure in all conditions



**EASY APP**  
Tablet barista's App for setting parameters



**OPERA IST WITH ACAIA DUAL SCALES**  
Embedded ACAIA dual scales system for a perfect coffee result in cup

 **Opera. The Revolution.**  
Link to the website.

**Characteristics**

 **AISI 316 STEEL GROUPS WITH 22 lb / 10 kg PURE STEEL**  
Exclusive Sanremo design ensure exceptional thermal stability and maximum resistance to oxidation and lime scale.

 **AISI 316 STAINLESS STEEL PORTAFILTER WITH "COMPETITION FILTER"**  
Exclusive Sanremo design, with shape and volume designed to capture the best coffee aromas and fragrances.

 **AISI 316 STAINLESS STEEL FREE MOTION STEAM TAPS**  
Flexible control system for producing and dispensing steam.

 **AISI 316 STAINLESS STEEL STEAM WAND "COOL TOUCH"**  
Anti-burning feature even in conditions of prolonged use, fitted with "Latte Art" high-performance steam terminals.

 **CONTROL COFFEE DELIVERY SYSTEM (CDS)**  
Three phases extraction parameters full control (pre-infusion, infusion, post-infusion).

 **INDEPENDENT ADJUSTMENT OF THE PID INFUSION WATER TEMPERATURE**  
Precision setting (gradient  $\pm 0.1$  °C with measured constancy lower than 0.2°C).

 **INFUSION WATER DISPLAY**  
Indicates tea and herbal teas water brewing temperature. (In the two group Opera it is shown with the steam boiler display)

 **STEAM BOILER DISPLAY**  
Indicates steam boiler temperature and pressure. (In the two group Opera it is shown with the infusion water display)

 **COFFEE UNIT SINGLE DISPLAY**  
Controls of all coffee extraction parameters.

 **MACHINE'S PROGRAMMING PARAMETERS DISPLAY**  
The internal display is a handy programming interface for the maintenance technician.

 **MIXED INFUSION HOT WATER FOR TEA AND HERBAL TEAS**  
Instantaneous mixing of fresh water and steam for a better chemical and organoleptic quality.

 **GEAR PUMPS**  
Dedicated to each individual group, allow to change the pressure during infusion.

 **STEAM CONTROL ADJUSTABLE ELECTRONIC PRESSURE SWITCH**  
Sensor with 0.02 bar precision that allows the chosen pressure and steam in the boiler to be kept constant in all conditions of use.

 **PROGRAMMABLE CUP WARMER TEMPERATURE**  
Allows the cups to be kept at the optimum temperature in the most different climatic conditions.

 **EASY SERVICE**  
Fast access to the internal parts for quick and easy technical service.

 **AUTO-DIAGNOSIS, STATISTICAL DATA, SCHEDULED MAINTENANCE**  
Maintenance can be scheduled according to litres or number of coffees dispensed.



 **AUTO-ON, AUTO-OFF AND DAY-OFF FUNCTION**  
Programmable on-off timer for each day and/or daily timetables.

 **AUTOMATIC CLEANING CYCLE**  
Process for coffee groups cleaning.

 **ENERGY SAVING SYSTEM**  
Insulation and smart energy management to save up to 30% of energy.

 **GROUP FLUSHING**  
With a simple pressure of the button a small quantity of water is dispensed to allow the group to be always clean.

**Optional**

-  **\* STAINLESS STEEL NAKED PORTAFILTERS**
-  **\*\* HIGH POWER STEAMER TERMINALS (bigger holes diameter)**
-  **\*\*\* EXTERNAL VOLUMETRIC PUMP**

TALL VERSION



# Opera 2.0

## Versions

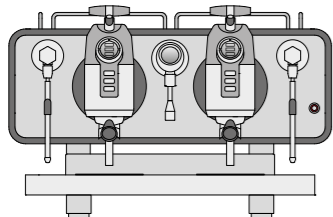

29.3 inches / 745 mm

### 2 group OP

- 2 steam taps
- 1 water tap
- 1 one-cup portafilters
- 2 two-cup portafilters

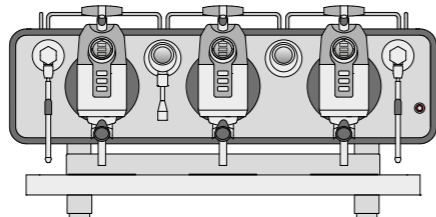

40.9 inches / 1040 mm

### 3 group OP

- 2 steam taps
- 1 water tap
- 1 one-cup portafilters
- 3 two-cup portafilters

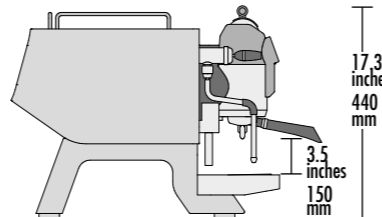

25.2 inches / 640 mm  
20.1 inches / 510 mm

### ✓ OPERA TALL VERSION

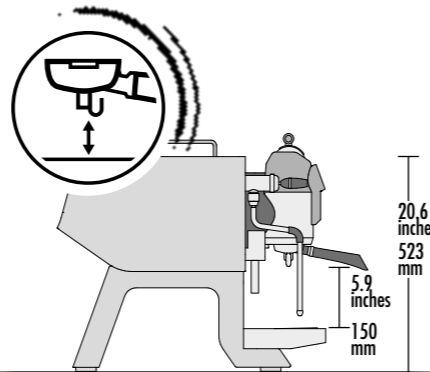

20.6 inches / 523 mm  
5.9 inches / 150 mm

### ✓ MULTIBOILER SYSTEM

High accuracy thermal stability thanks to the Sanremo multiboiler system with sophisticated electronic boards that continuously control temperature throughout all phases of extraction. Steam and coffee circuits work totally independent to maximize performance in every working condition (also under high workload).

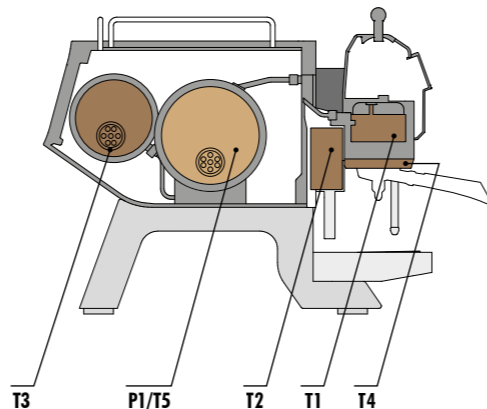

## Technical data

		2 group	3 group
voltage	V	220 / 240 1N	380 / 415 3N
power input	kW	7.7	8.75
steam boiler capacity	US gal / lt	2.11 / 8	2.64 / 10
services boiler resistance power	kW	3.8	3.8
external pump power	kW	0.15	0.15
preheating boiler capacity	US gal / lt	0.74 / 2.8	0.74 / 2.8
preheating boiler resistance power	kW	1.6	1.6
cup-heater power	kW	0.2	0.25
units boiler capacity	US gal / lt	0.264 / 1.0	0.396 / 1.5
units boiler resistance power	kW	1.6	2.4
net weight	lb / kg	200 / 91	249 / 113
gross weight (with shipping crate)	lb / kg	304 / 138	373 / 169.5

Great technology, user-friendly

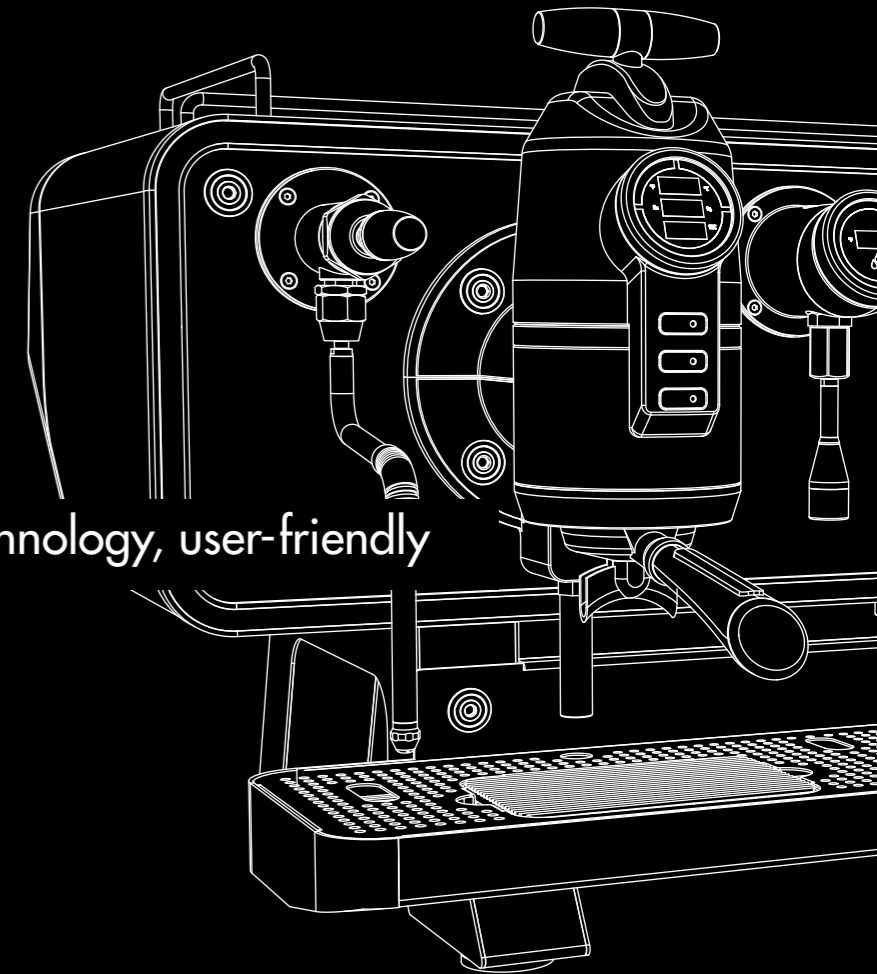

**OPERA**2.0  
THE REVOLUTION

# Opera

*a dream without boundaries*



Opera started from a dream, which is both innovative and simple. An international group of coffee experts reunited together with the **vision of creating the finest espresso machine ever built.**

The real users of coffee machines expressed their needs without any geographical or language barriers: having a precise tool which could allow them to **control and manage different parameters and extraction phases** in order to best evaluate each single or specific single origin coffee blend.

Sanremo has organized a superior team starting from the initial brainstorming until the finish line, the Opera... this is a story about us, our experience, determination and passion.

Opera was born by a dream without boundaries. Now the Opera has become a reality for the world to experience.



**Opera. The full story.**  
**Watch the video.**



# OPERA<sup>2.0</sup>

THE REVOLUTION

## Standard models

*wide choice of version*



✓ **Opera Black**  
Standard back panel: [BP5]



✓ **Opera White**  
Standard back panel: [BP2]



✓ **Opera Steel**  
Standard back panel: [BP1]

Opera was created to surprise in all its details: technological excellence is perfectly combined with the lines of its unique design, making it stand out and become a style icon. It also ensures ergonomics and user-friendliness in each operation for baristas, making it unparalleled among those of its kind.



**BP1** Etched crystal / backlight



**BP2** Painted wood

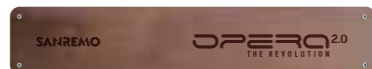

**BP3** Steel oxidized / backlight



**BP4** Blackboard graphite rewritable



**BP5** Black / backlight



**BP6** Octane blue / backlight



## Choose the panel

*to suit your style*



Back panel of each version can be customized, with finishes that meet all your needs and vision.

For example, from the blackboard to write promotions and offers for the customers, to the natural wood, to crystal or oxidized steel which give the possibility to engrave, carve or screen print a logo or a pattern...

Tailor made finishes  
collection 2018



✓ **Opera Octane**  
Standard back panel: |BP6|

Intense, enveloping, defined: teal is a dye with a strong, bold, and elegant character, which perfectly matches Opera dark lines and flawless performances: for those who love trends that rhyme with sophistication.



✓ **Opera Oxid**  
Standard back panel: |BP3|

Pure steel manually oxidised in its external parts, to further sign the tailoring of each Opera with a unique and inimitable aesthetic touch: for those who love to own original collector's items.



# Control Delivery System

to act on all the extraction phases

Extraction examples of different coffee types:

- BLEND / A
- BLEND / B
- SINGLE ORIGIN / C

Every single origin or coffee blend has its own organic characteristics that are best expressed using different infusion styles.

By manipulating different variables and concentrations the barista can fine tune each extraction to suit their specific origin, density and roast style.

All this guarantees allows the barista to manage the amount of high pressure each coffee bean is exposed which not only preserves all of their aromas but also enhances their best features.

Opera is a professional machine that gives the baristas the opportunity to really express themselves.

The CDS (Control Delivery System), gives the barista precise control of extraction in three phases: pre-infusion, infusion and post-infusion, considering the density and roasting of the bean.

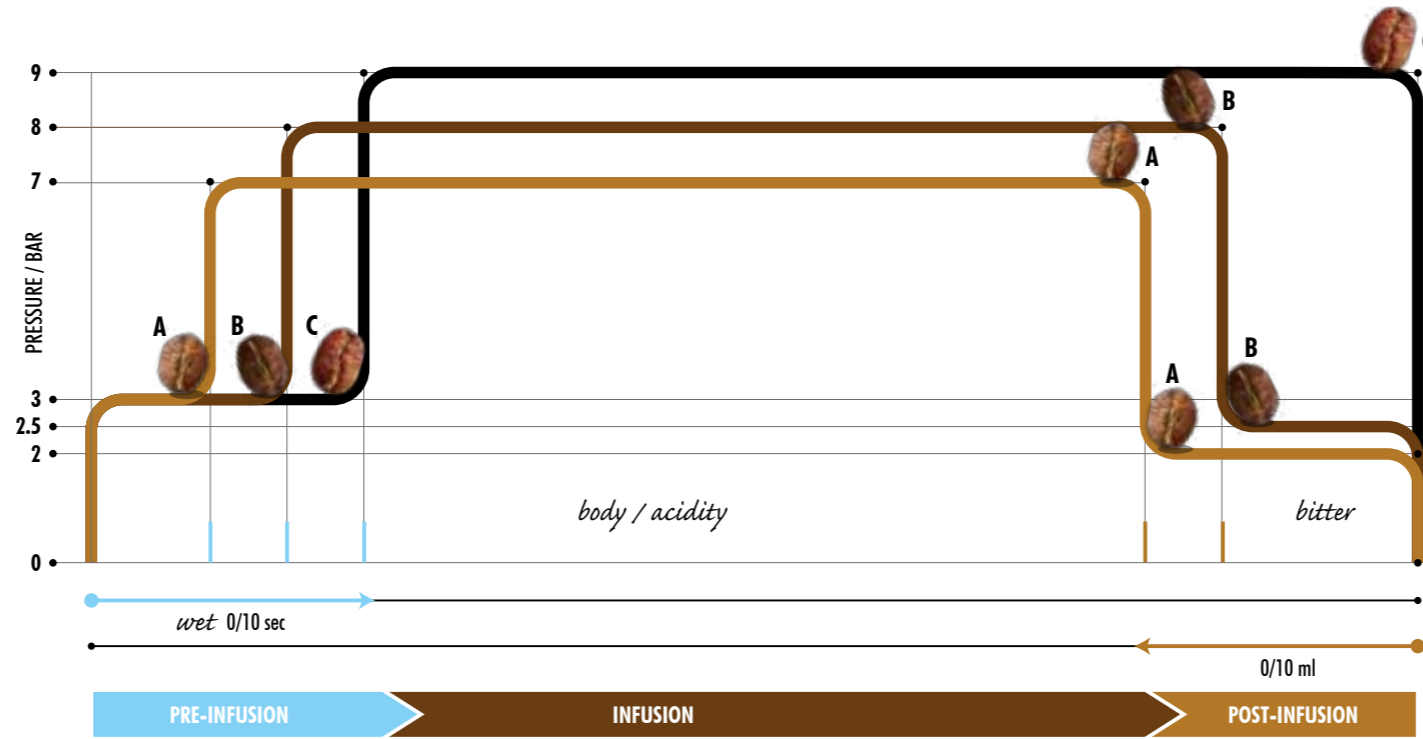

TOTAL EXTRACTION TIME 25/30 sec

TOTAL EXTRACTION VOLUME 80 ml



## Pre-infusion with soft pressure

The different physical characteristics of each coffee bean, as well as its degrees of roasting and grinding, all affect the extraction process. To obtain a perfect and homogeneous extraction it is essential to control the parameters of the pre-infusion.

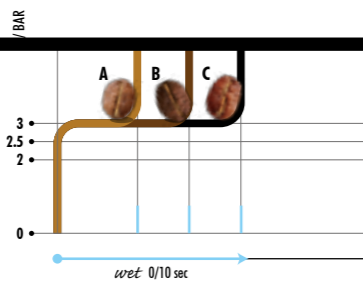

The pre-infusion is the first phase of the coffee extraction: its function is to get the powder wet and prepare it with a soft pressure (max 3 bar) for the following and optimal extraction. The pre-infusion also allows the coffee grinds to gently expand before the infusion stage which reduces the chance of channelling.

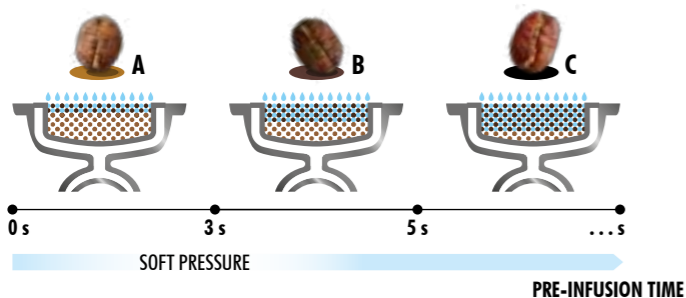

## Infusion at the maximum thermal stability

Thanks to the highest quality components, precision sensors (5 control points) and the **Multiboiler System**, Opera ensures the maximum thermal stability, adjustable to the tenth of a degree °C.

The **Tempcontrol** system allows to separately modify the water temperature for dispensing and the temperature of each group very quickly.

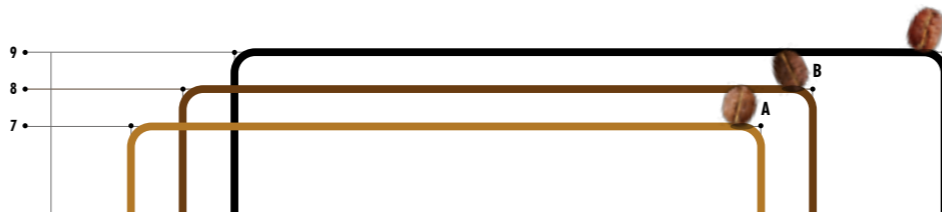

The outstanding performance of the **Pressure Drive** system, a gear pump for each group, allows an independent regulation of the ideal pressure during the infusion.

All this guarantees the perfect switch point to the coffee layer, which is the correct duration of exposure to the high pressure, preserving all the aromas, enhancing their best features.

## Post-infusion, to collect until the last note

Depending on the type of coffee used, the regulation of a post-infusion, which may be long or short, can improve the result in the cup and eliminate the bitter notes, which may compromise the quality of the extraction.

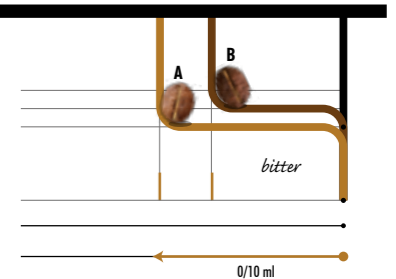

Opera allows the adjustment of the parameters of this delicate phase, defining then the final dose dispensed in the cup (in ml or g).



The post-infusion allows to accomplish the coffee infusion in the final phase of the extraction at a lower pressure, continuing to extract soluble substances and aromas without increasing the bitter notes caused by the high pressure overextraction that normally occurs in this phase.



## Everything under control

group display for coffee brewing



boiler display and hot water supply

Just a quick review: highly precise electronic sensors detect pressure, temperature, and water level. These measurements are constantly monitored in real time and accessible in a fast and secure way.

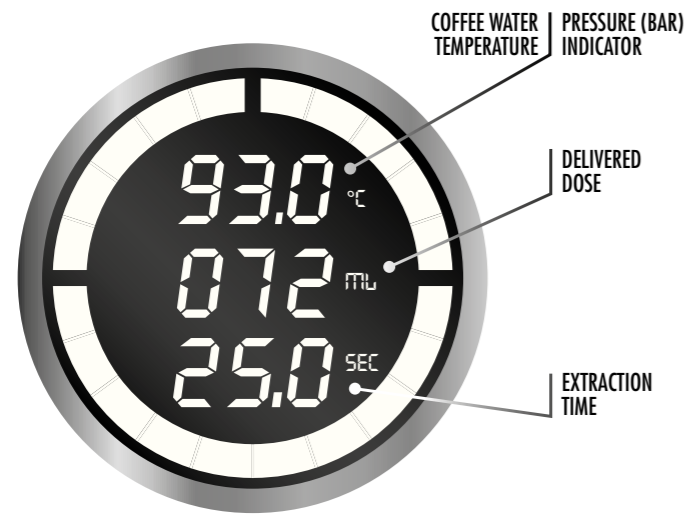

Through the group display the barista can keep control of all the phases and extraction parameters according to the set profiles for that particular group:

- **water temperature**  
precise and constant throughout the extraction step
- **pressure** diversified for the 3 phases: pre-infusion/infusion/post-infusion
- **delivered dose (ml)** \*
- **extraction time**

\* in the scales version it is even possible to control the espresso's weight in cup

For each group it is possible to set 6 different flavor profiles utilizing the push/pull lever in conjunction with the 3 selections of buttons.

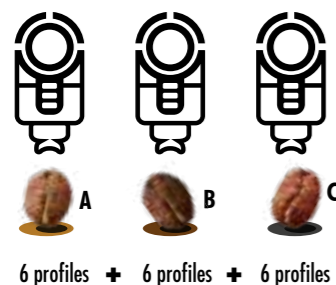

**Up to 18 programmable profiles with the 3 group model!**

Different independent groups with multiple profiles optimize the use of single origin coffee or different blends in line with new market trends.



3 GROUP DISPLAY



2 GROUP DISPLAY

## Power Dry Steam

high performance steam function

Opera guarantees high performance and dry steam thanks to the electronic control system through an advanced transductor.



Use the best Sanremo technology, with impeccable performance, to give free rein to your creativity:

- dedicated steam boiler (high capacity and fast recovery)
- free motion steam taps
- cool-touch steam wand



# Everything in an App

app dedicated to parameter settings for tablet

**(step A) GROUP SELECTION**

**(step B) PUSH / PULL LEVER SELECTIONS OF BUTTONS**

**(step C) SELECTIONS OF PROFILE BUTTONS  
PUSH / dose 1,2,3  
PULL / dose 4,5,6**

**(step D) TEMPERATURE REGULATION**

**(step E) DOSE REGULATION**

**(step F) INFUSION REGULATION**

For each group it is possible to set:

### Temperature

- water temperature **T2**
- group temperature **T3**
- steam temperature **T5**  
(unique boiler for all groups)

### Dose

- weight of ground coffee
- water dose
- pump pressure
- coffee weight

### Infusion

- timing
- pump pressure
- amount of water

With the interface “*Express yourself*”, the barista has total control of the extraction phase of his coffee and can manage each dispensing parameter according to his experience and professionalism.

To configure and set all the parameters of the machine, a specific App has been designed, which runs on smartphone, tablet, pc...

The application “*Express yourself*” utilizes a graphic interface, it is both user friendly and intuitive. This interface allows the user to set each groups relative parameters accurately for the perfect extraction.

Upon choosing the group (step A) and assigned a configured profile (step B,C) will define the general parameters of extraction: temperature and doses (step D,E). At the end it is possible to adjust the parameters relative of the 3 extraction’s phases: pre-infusion, main infusion, post-infusion (step F).

Pre Infusion: 2.5 s

3.5 bar

### PRE-INFUSION



Main Infusion: 71 ml

Pressure: 9.0 bar

### INFUSION



Post Infusion: 2 ml

3.5 bar

### POST-INFUSION



### (step F) Adjust the 3 extractions phases

This operation is simplified by the App. Everytime the user modify one of these parameter the software update automatically. What was set prior to the modification.



### CONFIGURATIONS

- STANDARD
- STRONG
- BALANCED
- SWEET & LIGHT
- ... N (set by the user)
- ... N (set by the user)

It is possible to save and recall new configurations set by the user or the default ones, specifically designed to allow even the less experienced bartenders to obtain immediately excellent results in the cup.

Clicking in “save new configuration” you can save your perfect espresso dispensing menu and transfer it through the Bluetooth connection into another machine.

# Opera wi-fi

*the easiest way*



Since today on the new Opera 2.0 is easier to handle, thanks to the **Sanremo Cloud** and **Webapp Expressyourself** interface, for an even easier and interactive using experience.

- Handling through Sanremo app, from smartphone, tablet, or pc, of all configuration parameters of the machine, without the need for physically being in front of it.
- Possibility of connecting multiple machines simultaneously for sharing, modifying, and setting of recipes and configurations.
- Simultaneous monitoring and handling of multiple machines by the same owner (e.g.: franchising in different locations).
- Statistical analysis of consumption, distribution, maintenance, configuration for all connected machines.
- Remote maintenance by the technician for updating, verification of the correct settings and parameters control.

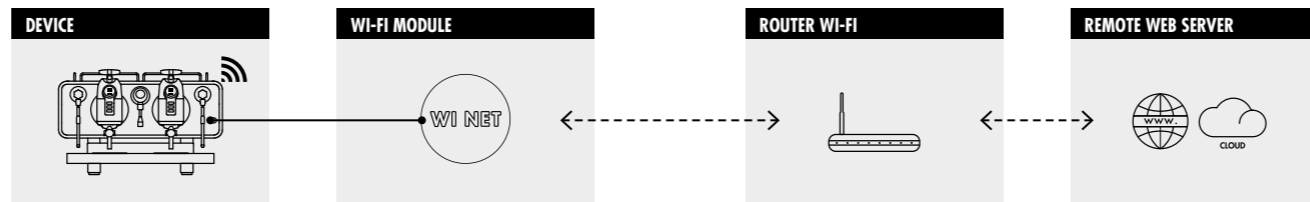

## INTRANET (LOCAL WI-FI NETWORK)

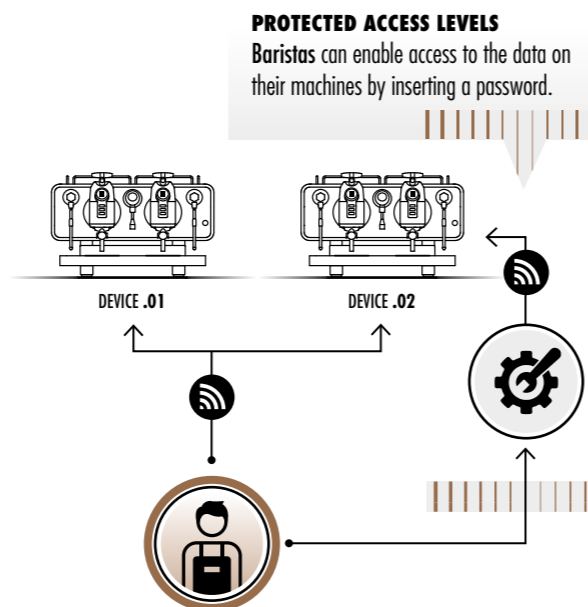

- PLUS + (USING THE LOCAL WI-FI NETWORK)**
- Reading and changing machine settings and parameters
  - Consumptions analysis for a better stock management
  - Meters reading of the coffee dispensed
  - Saving, restoring and sharing of settings (recipes) on your machines

Data exchange can only be effective in the wi-fi range.

## INTERNET (GLOBAL NETWORK) / SANREMO CLOUD

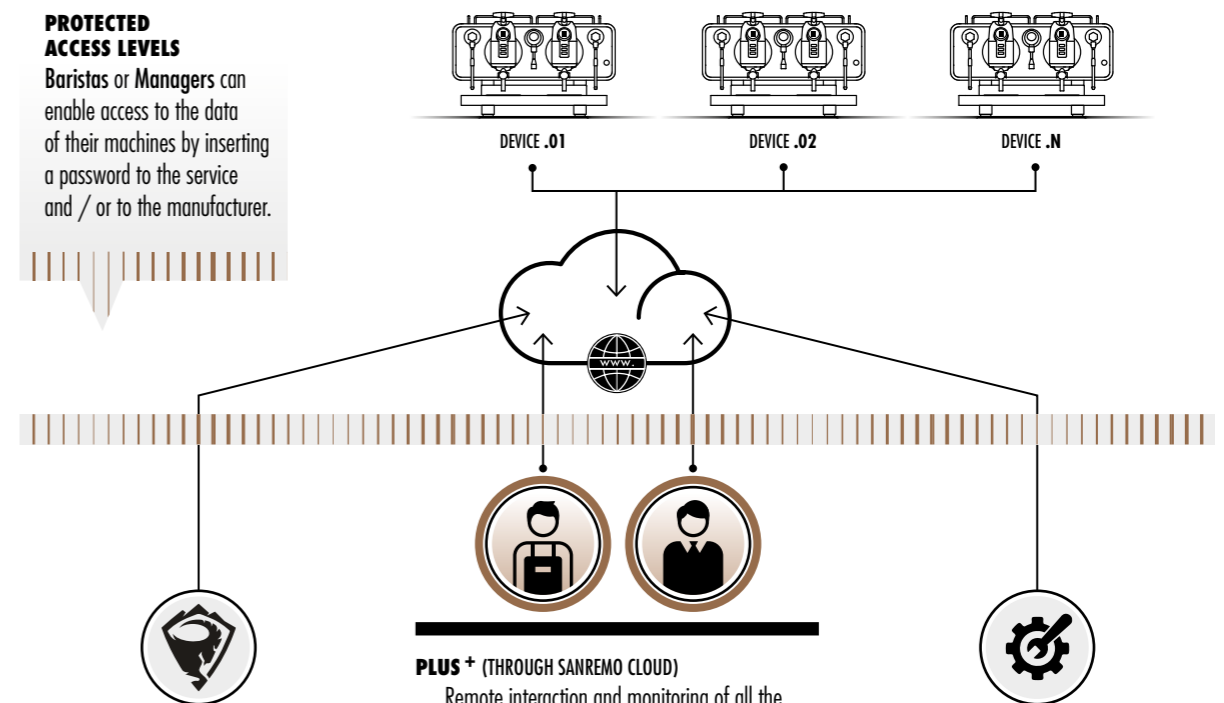

- PLUS + (ENABLING THE MANUFACTURER)**
- Sending of App updates to the machines
  - Sending new settings (recipes)
  - Clearer and faster data collection aimed to resolve any technical/constructive problems
  - Useful information for the improvement and evolution of the product
  - Direct and continuous contact with the manufacturer

- PLUS + (THROUGH SANREMO CLOUD)**
- Remote interaction and monitoring of all the functions and performances of the machine
  - Reading and changing of the machine settings
  - Display of historical usage data
  - Consumptions analysis for a better stock management
  - Meters reading of the coffee dispensed
  - Saving, restoring and sharing of settings (recipes) on your machines

- PLUS + (ENABLING THE SERVICE)**
- Immediate report of anomalies
  - Diagnosis and possible remote troubleshooting
  - Reduction of machine downtime
  - Logistic planning and organization of maintenance interventions

- BARISTA**
- MANAGER**
- MAINTENANCE SERVICE**
- MANUFACTURER**
- SANREMO CLOUD**
- INTERNET GLOBAL NETWORK**
- LOCAL WI-FI NETWORK**



Developed in  
cooperation with



Innovative Scale Technology

**100% accuracy**



## Brew Ratio Control

*the way to a correct extraction*



In order to get a perfect result in the cup it is absolutely necessary to use the right amount of water as a function of grams of ground coffee that we have in the portafilter.

Generally for the modern espresso is extracted from 18-21 g of ground coffee, but how much product do we need to extraction in the cup for that perfect espresso?

The volumetric measurement method not ideal to test a correct extraction, because the crema influence a lot the volume of espresso.

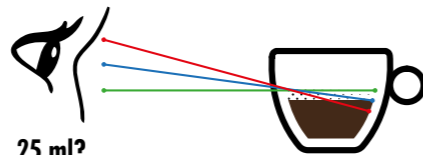

**25 ml?**  
It depends on the point of view...

Only the control of the **Brew Ratio** is achieved through the measurement of the weight of coffee in the filter and the weight of the dispensed product.

To achieve our target we have equipped **Opera IST** (Innovative Scale Technology) with scales that allow the barista to control the amount of product in the cup and reach the desired **Brew Ratio**.

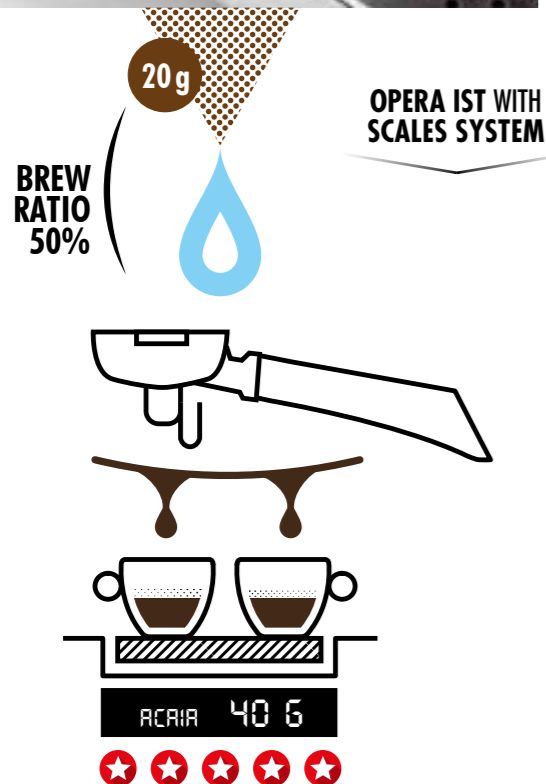

Thanks to Opera's sophisticated technology with scales it is possible to ensure the perfect measurement of the desired **Brew Ratio** and obtain a perfect result in the cup.

## Innovative Scale Technology

*lets you make utterly perfect coffee each and every time*



The Opera IST system is a Sanremo project developed in cooperation with **Acaia**.

This system is at the forefront of technology and production quality. It lets you make utterly perfect coffee each and every time thanks to the **Brew Ratio Control**.

The barista can now operate with the machine not only through dosing the amount of water, but also **visualizing the weight of the coffee in cup**.

This way it is possible to "customize" every single brew as wished.



"Dual" scale for Sanremo  
Opera IST profit by Acaia Weighing Technology:

- Real-time weighing result feed back to each group head
- Noise filtering
- Zero tracking
- 1 Million internal resolution counts
- USB Rechargeable Battery

- Calibration
- Accuracy Readings from 0.1g / 0.01g
- Error Margin  $\pm 0.05g$  (0.5%)  
*A rusty traditional mechanical scale has an error range of:  $\pm 1g$  (10%)*



---

*For more information about our  
coffee machines please contact us  
at [export@sanremomachines.com](mailto:export@sanremomachines.com)*



**SANREMO**  
COFFEE MACHINES

SANREMO coffee machines s.r.l.  
Via Giacomo Bortolan 52  
31050 Vascon di Carbonera [TV] – ITALY  
T +39 0422 448900  
F +39 0422 448935  
[www.sanremomachines.com](http://www.sanremomachines.com)